



# Impact of Supply Chains on Major Capital Projects

PPI Symposium  
November 29, 2017

Majority of MCP cost is rooted in the supply network

For the most part owner operators buy products and services either directly or through some agent i.e. CM

Project performance cannot be optimized without addressing the implications of the supply network



Supply Chain Management is not well understood amongst project professionals resulting in significant loss of value



Why is this important?



## Less Control of Time to Market

- Project delivery process takes longer than it should (having to start earlier)
- Difficult to terminate project once started
- Lost opportunity cost / Cash tied-up in project versus other investment

## Make Decisions Sooner Than Optimal

- Sanction prior to what's ideal
- Commit to technology and vendors too early (market dynamics not understood)
- Potential for obsolescence

## Unnecessary Cost Related to Handling and Holding

- Preservation and Storage
- Damage and theft



# Case Examples



# Conventional Supply Chain Conceptual Model

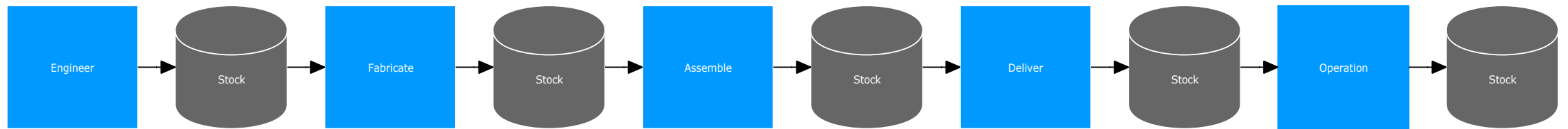

# Gorgon Cost of Decoupling Inventory Buffer

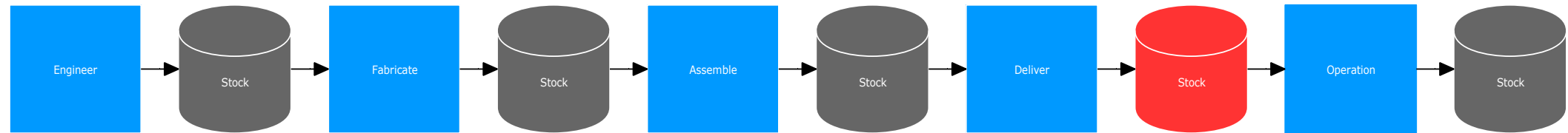



# Impact of Siloed SCM/Procurement Strategies

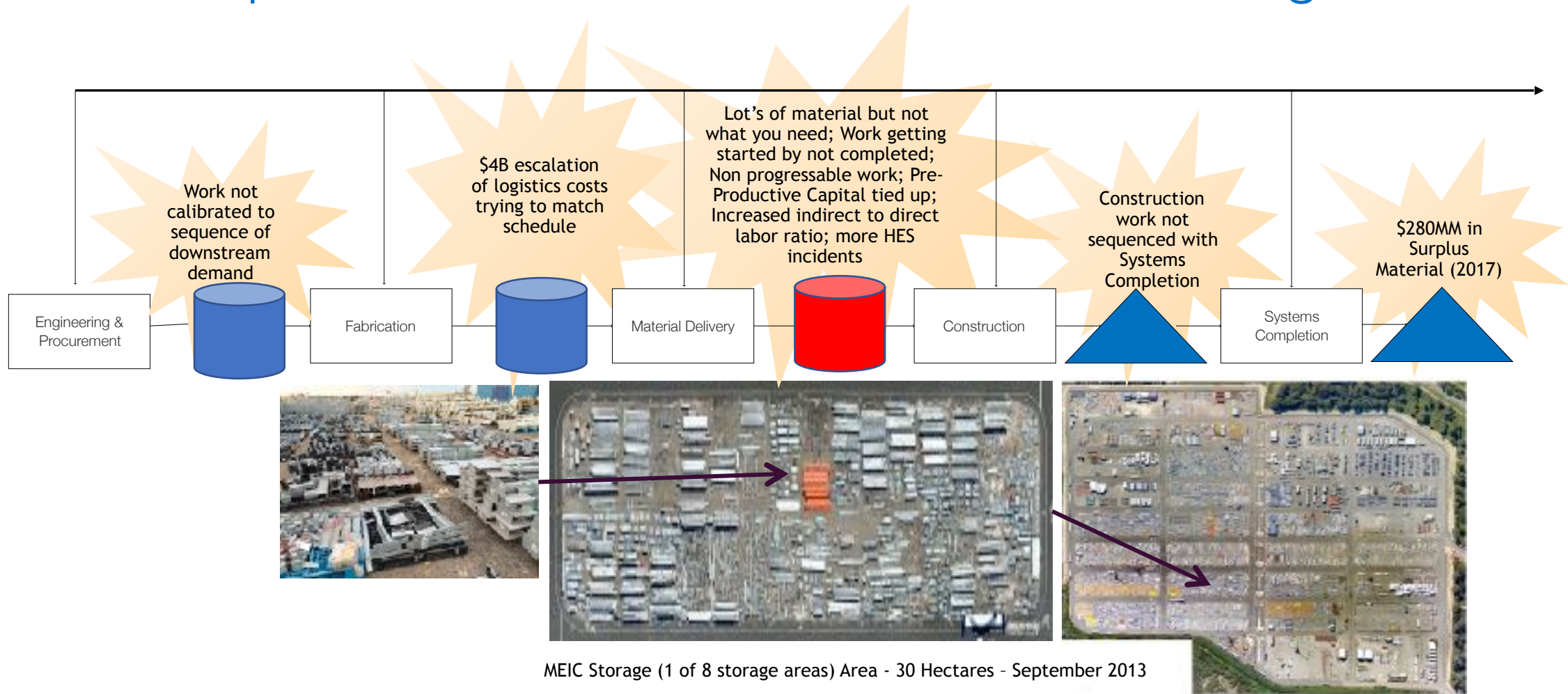

“Had we pressed the reset button, we could have saved \$10B.”  
(Gorgon Project Director at the LL Workshop in February, 2017)



# Default design of an MCP Supply Chain

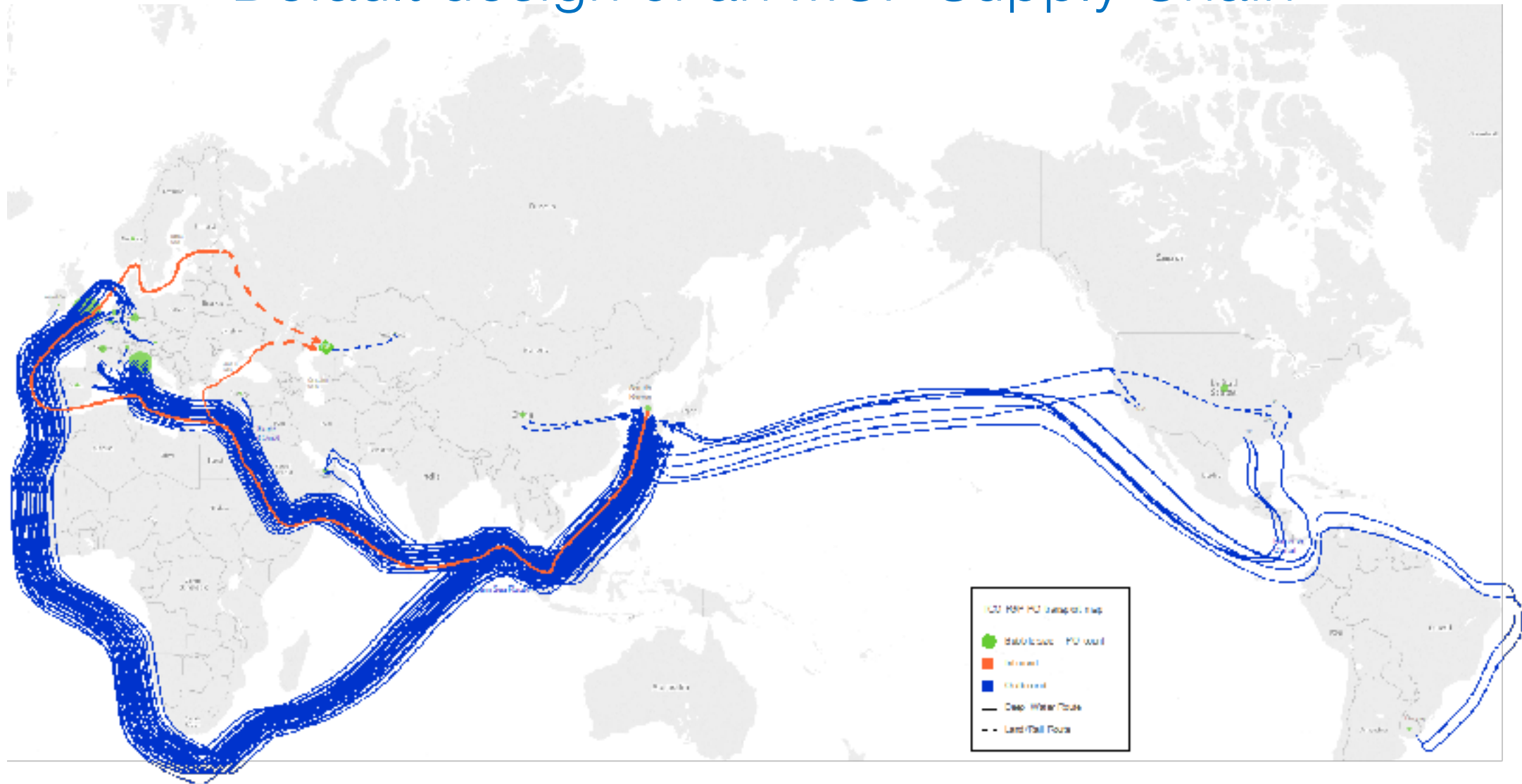

# Multiple Sources of Variability of Supply Delivery

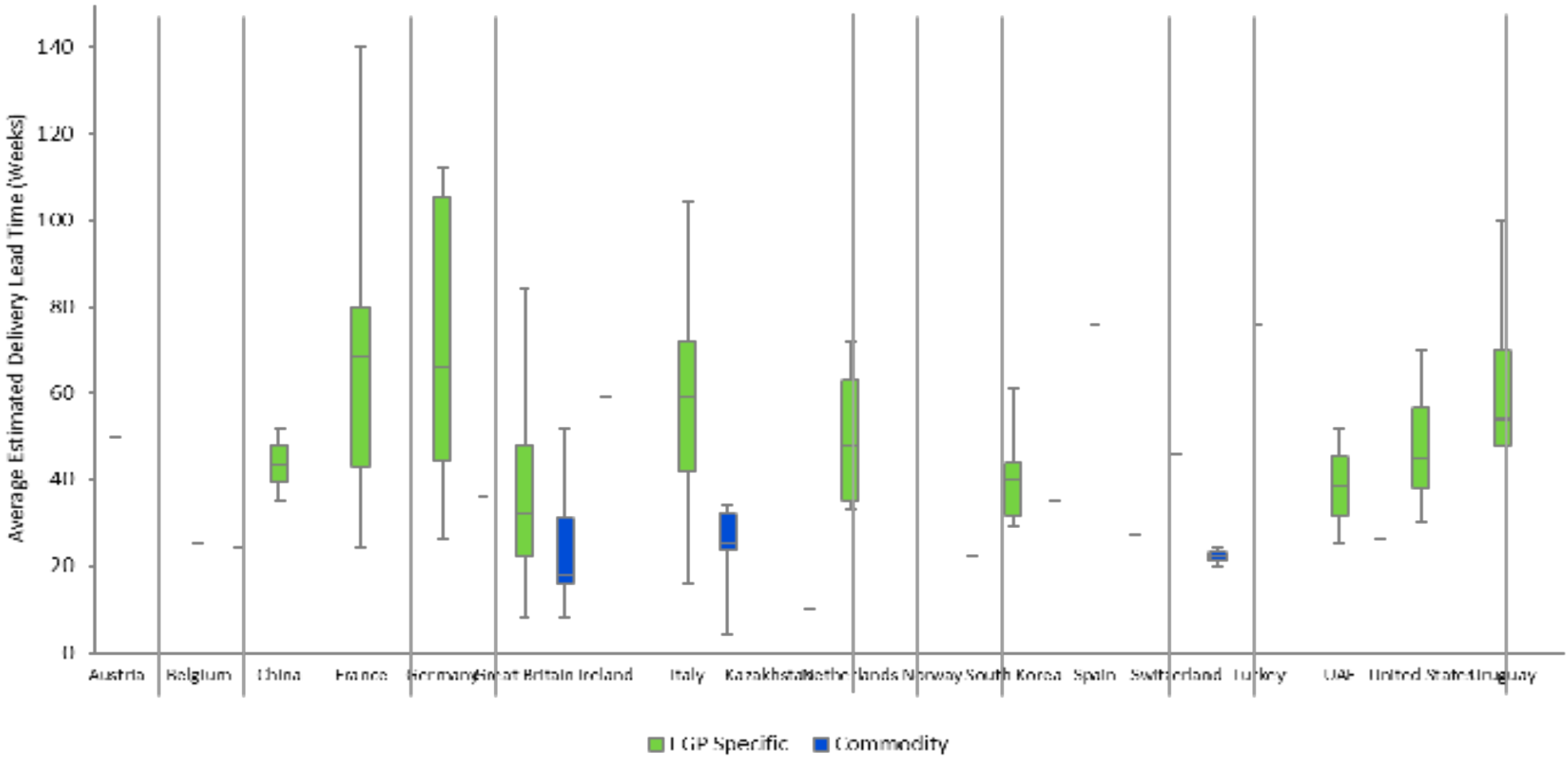

# Detailed Production Systems for PAUs (Modules)

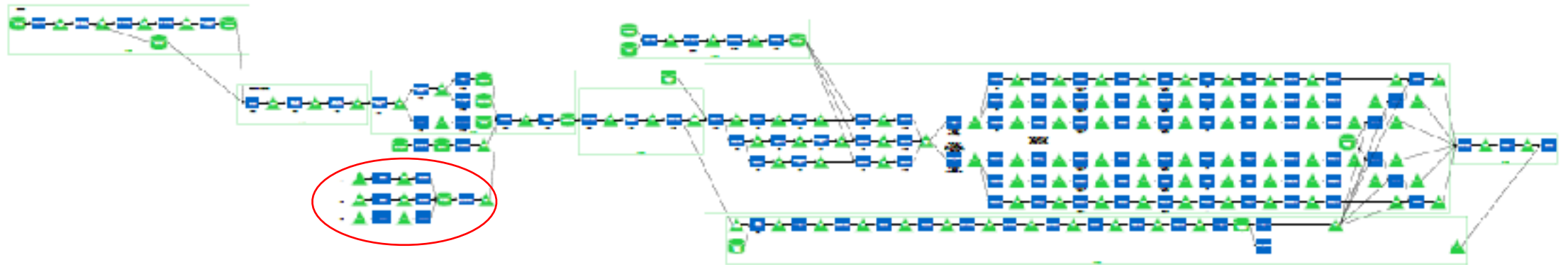

# Same Production System with Inbound Supplies Route

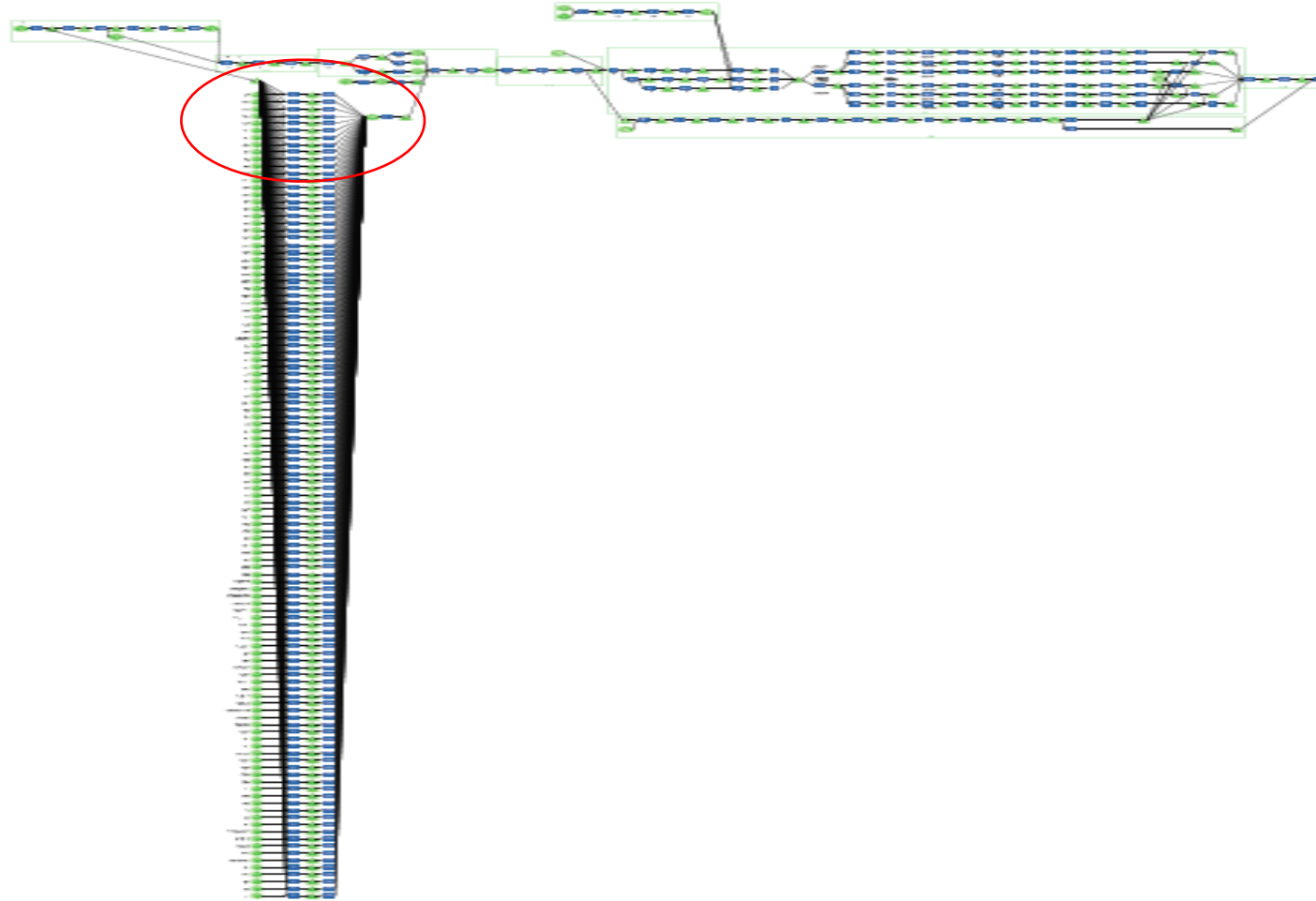

# Schedule Demand vs Production Delivery

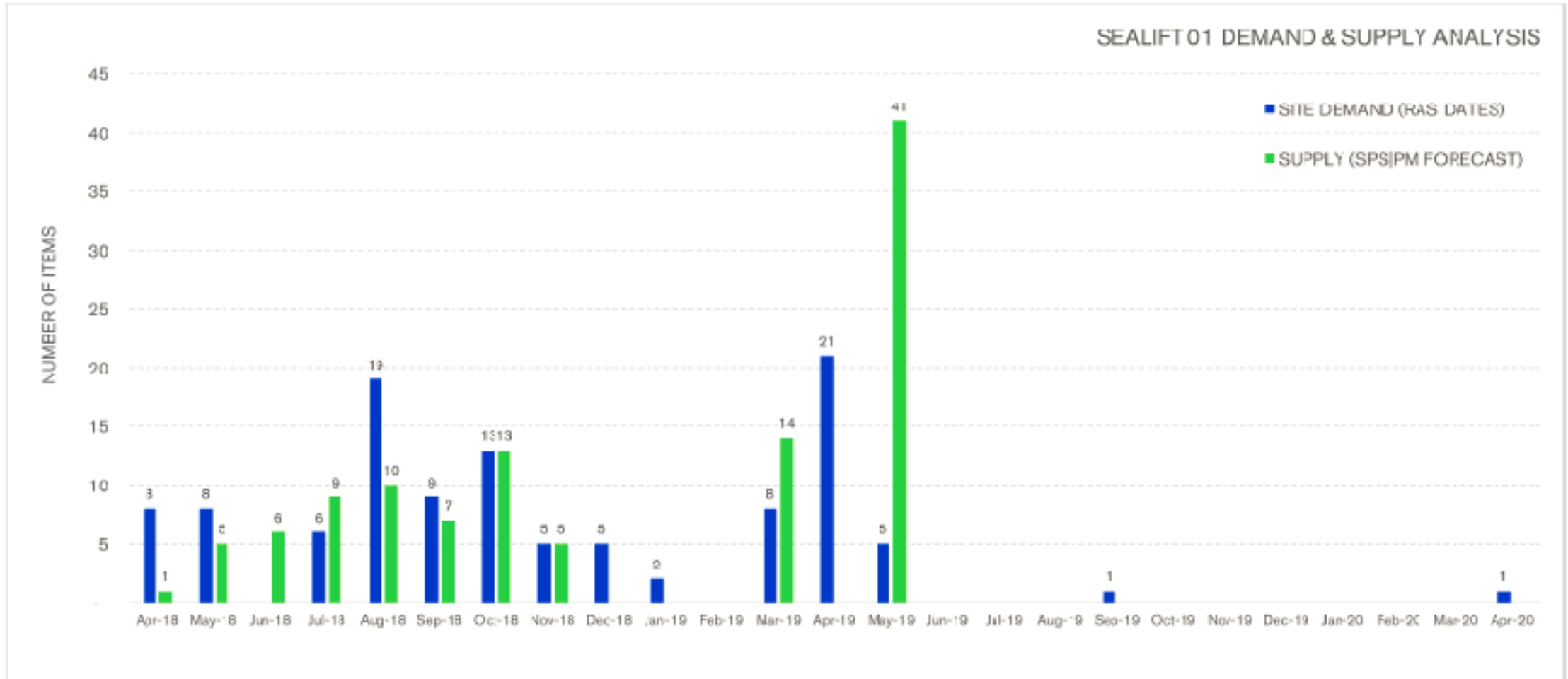

# Competing Business and Delivery Objectives of Supply Chain

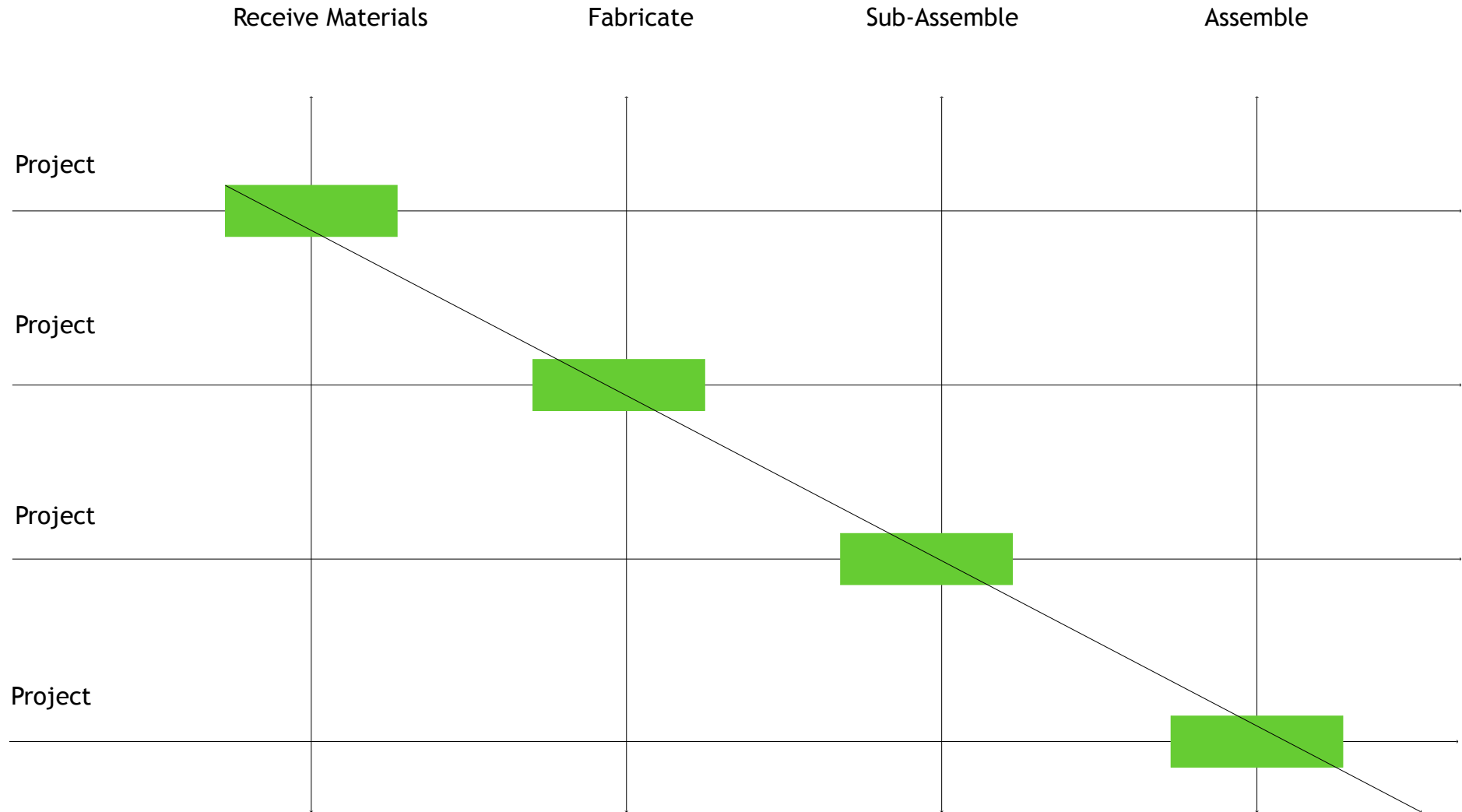

## GOAL

Achieve Desired Production Throughput Rate Using  
Optimal Capacity and Inventory



## STRATEGY

Synchronize Execution of Work Through PPS



## ACTION

Improve Reliability of Work Execution & Flow  
While Compressing Lead Time





Reliability of  
Workflow



Lead Time of Supply



# Model of Desired Future State

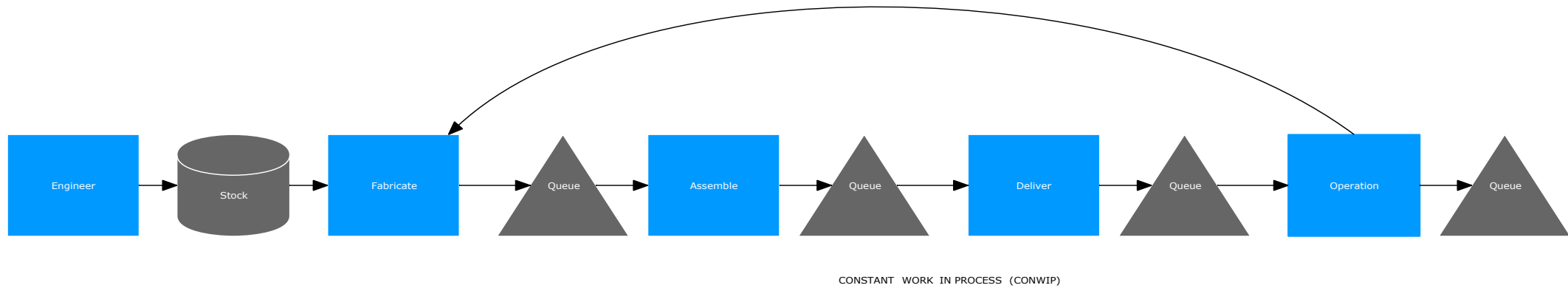

Improve Reliability of Work Execution & Flow While Compressing Lead Time



# Example: Applying CONWIP to Short Range Planning Process

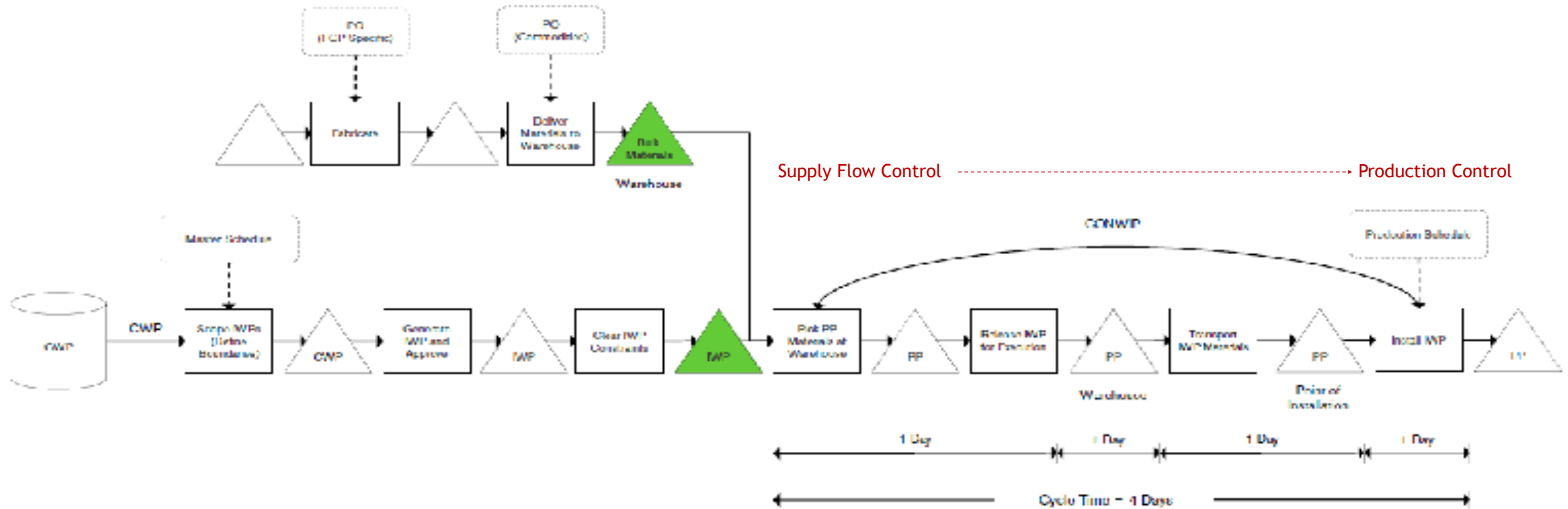

## Configuring a Pull System for Short Range Planning

1. Compress lead time between warehouse to point of installation
2. Establish reliability of work rate at the point of installation (control variability with Production control)
3. Establish reliability of supply to the point of installation (Supply Flow Control)
4. Synchronize flow of supply and demand for all trades to all workfronts (Constant Work in Process (CONWIP) signal)



Majority of MCP cost is rooted in the supply network

For the most part owner operators buy products and services either directly or through some agent i.e. CM

Project performance cannot be optimized without addressing the implications of the supply network



Questions?



# Appendix



# Establishing the rules and policies of a Pull system for Short Range Planning

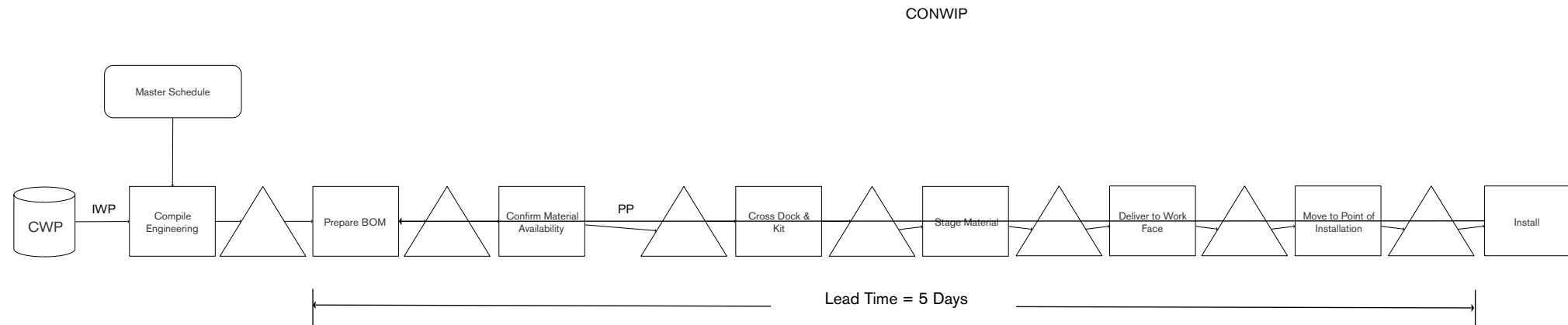

1. Initiate production of a PP from the worksite (CONWIP)
2. Contain no more than one day of field installation work in a PP
3. Include all necessary technical information in a PP
4. Check for accuracy / quality of PP's at the logistic center and notify of issue
5. Kit today what will be delivered tomorrow
6. Optimize offloading sequence and parts presentation to the extent possible
9. Optimize kitting / delivery capacity within the day – no more
10. Deliver today what will be installed tomorrow
11. Ensure PP is sound when receiving at workforce
12. Use trailers for staging when possible
13. Offload from trailer to Point of Installation (POI) when possible
14. Remove from site what is not consumed (waste, dunnage, rejected PP's, etc.) daily
15. Inspect and accept completed work on a daily basis



# Fortunately, there is another way to look at project delivery

<b>ERA 1 - PERSONAL PRODUCTIVITY</b> 1910's -	<b>ERA 2 - PROCESS PREDICTABILITY</b> 1950's -	<b>ERA 3 - PRODUCTION PROFICIENCY</b> 1990's -
Scientific Management	Project Management	Production Management
How to get more out of workers	Scope, cost and time trade-off	Projects are Production Systems and should be managed as such
Functional foreman, time and motion studies, Gantt chart,	PERT, CPM, EVA, Construction Management	Application of Operations Sciences to project delivery process and supply network including PPC - variability and inventory
Taylor, Gilbreth's, Hauer	US DoD, DuPont Remington Rand, PMI	Stanford CIFE, UCB P2SL, PPI

Adapted courtesy of Project Production Institute, 2017

